



## **Cast Versions of Wrought Alloys: Candidates for Steam Turbine Casings**

Paul D. Jablonski and Christopher J. Cowen  
with Phil Maziasz at ORNL



# Past Capacity Announcements vs. Actual

## Figure 1

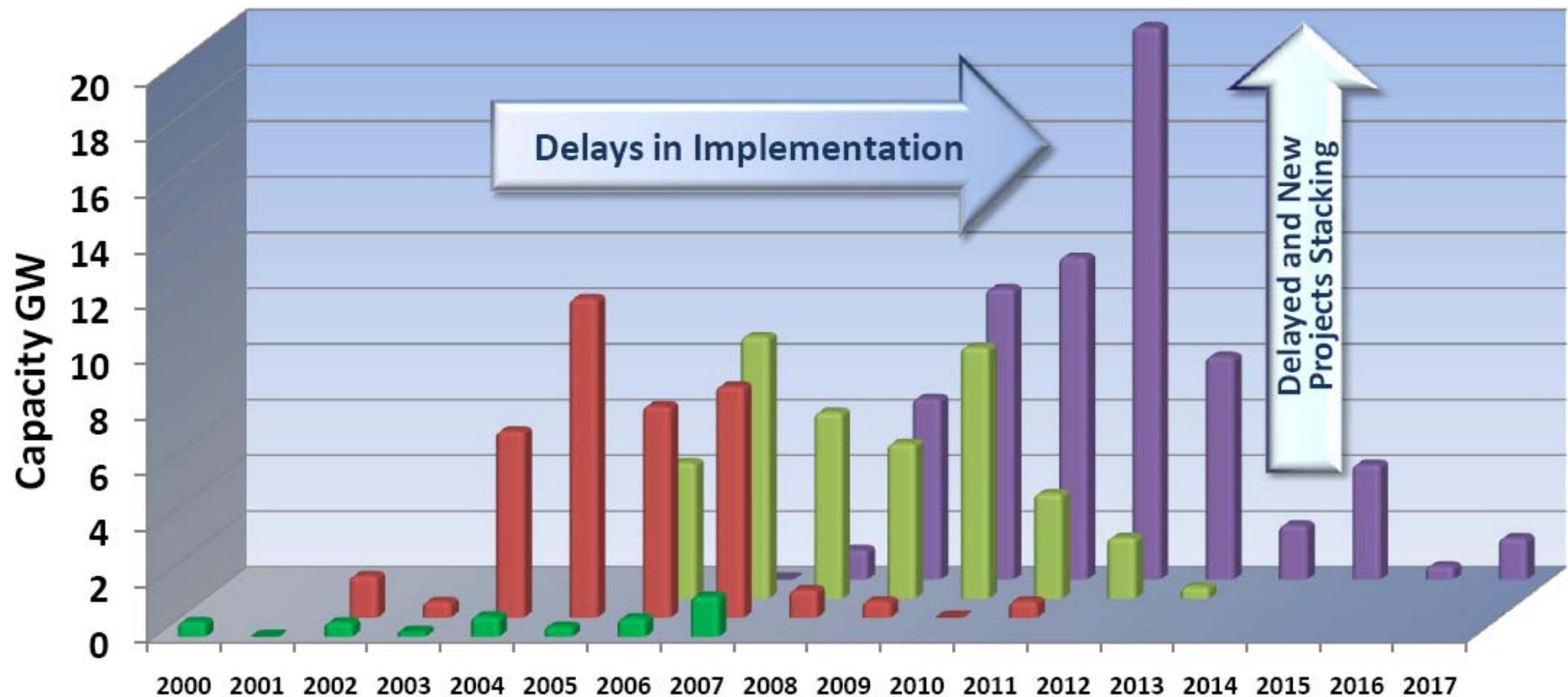

Historically, actual capacity has been seen to be significantly less than proposed capacity. For example, the 2002 report listed 36,161 MW of proposed capacity by the year 2007 when actually only 4,478 MW (12%) were constructed.

■ Actual   
 ■ 2002 Report   
 ■ 2005 Report   
 ■ December 2007



# Increasing Efficiency: USC Plants

US-DOE Advanced Power System  
 Goal: ~46% efficiency from coal generation  
 Steam condition: 760C - 35MPa  
 ~5ksi

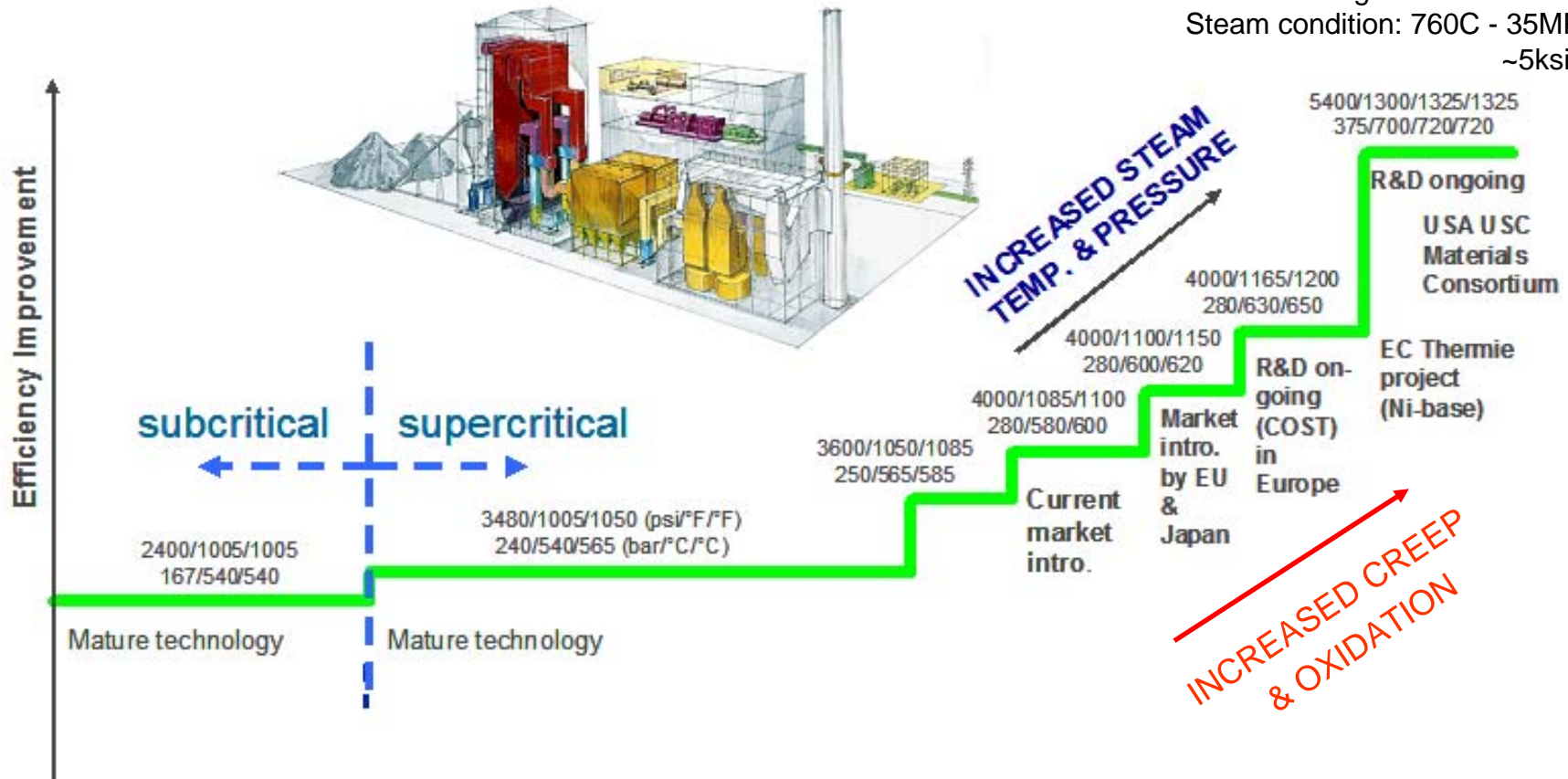

Plants operation above 22MPa at 538 to 565C are “supercritical”; above 565C are “ultra-supercritical” (USC)

Source: Viswanathan, et al 2005

# Effect of Increased Efficiency On CO<sub>2</sub>

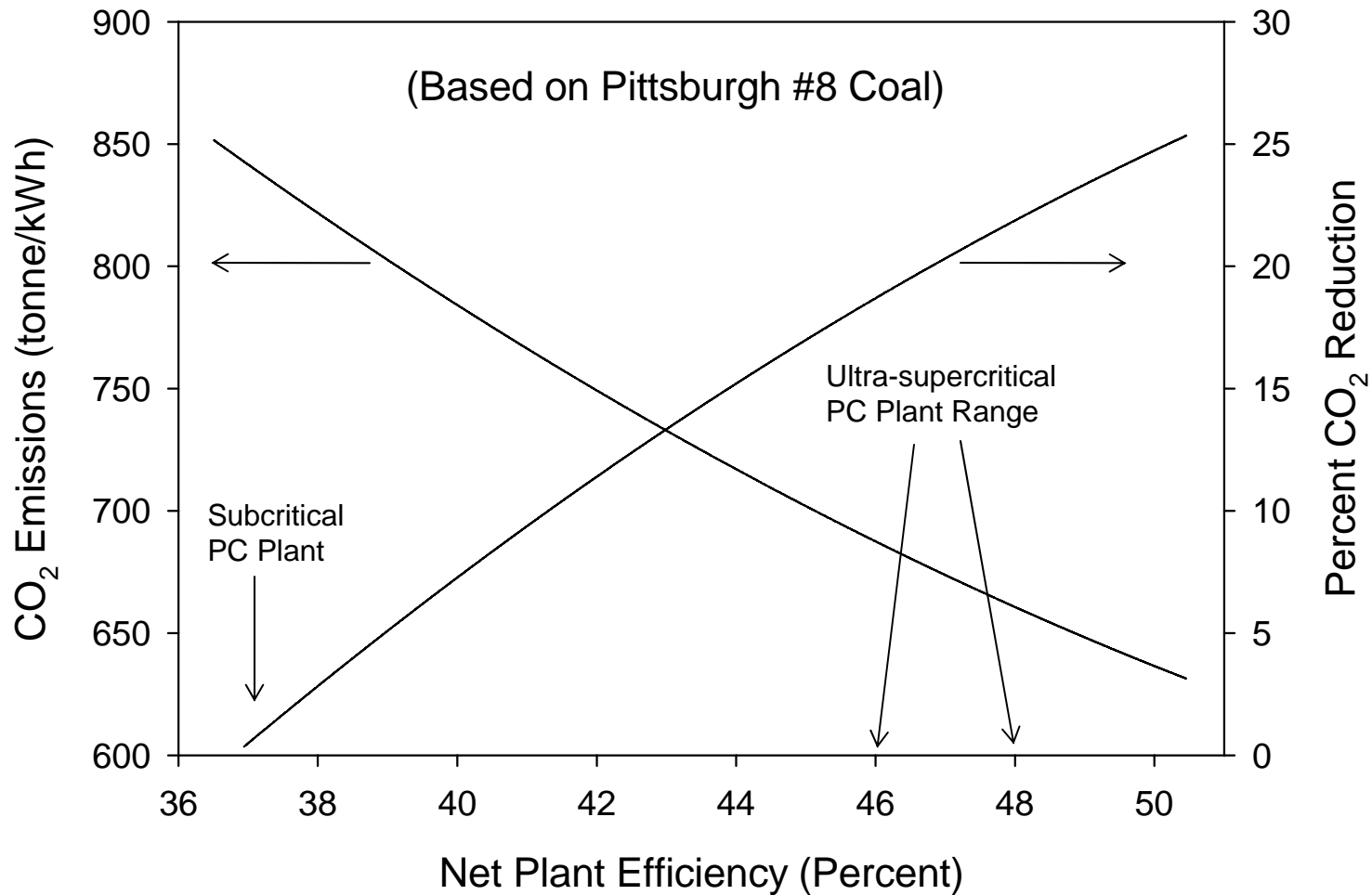

# Technological Issues

- **There is an immediate and continuing need for increased power production.**
- **Increases in Temperature and Pressure increase efficiency and decrease CO<sub>2</sub> production along with other pollutants.**
- **Higher Temperature and Pressure place greater demands upon the Materials.**
- **Large castings are required—many technical issues.**



# Maximum Use Temperature

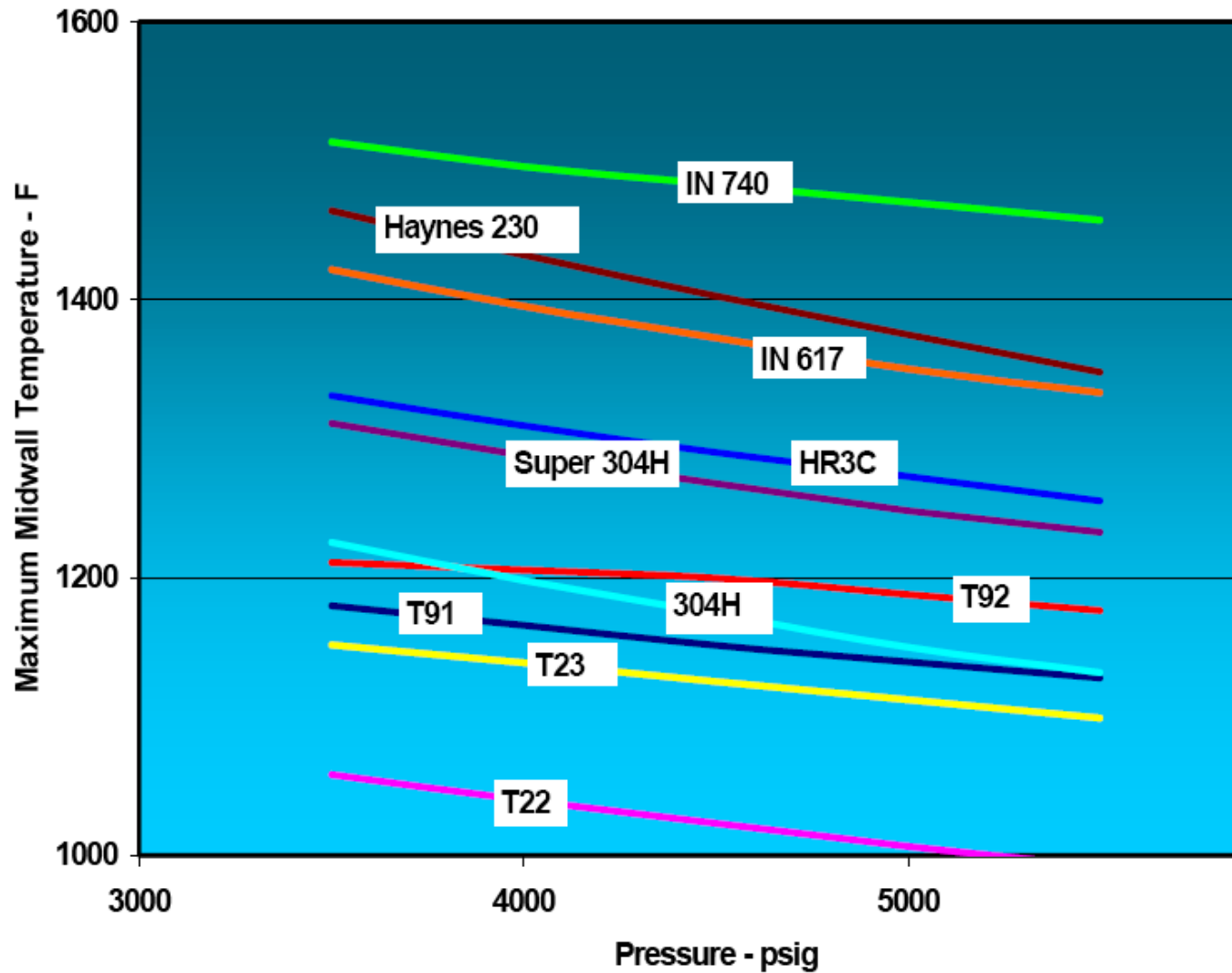

# Challenges for USC Castings

- **Alloys contain elements with high oxygen affinity such as Al and Ti**
- **Large pour weights (1-15T)**
- **Thick section components**
  - Slow cooling rates
  - Segregation prone alloys
- **Our approach is to examine a suite of traditionally wrought Ni-based superalloys cast under conditions designed to emulate the full sized casting.**

# Example Components

- **Castings**
  - 1-15 tons
  - Up to 200mm in thickness

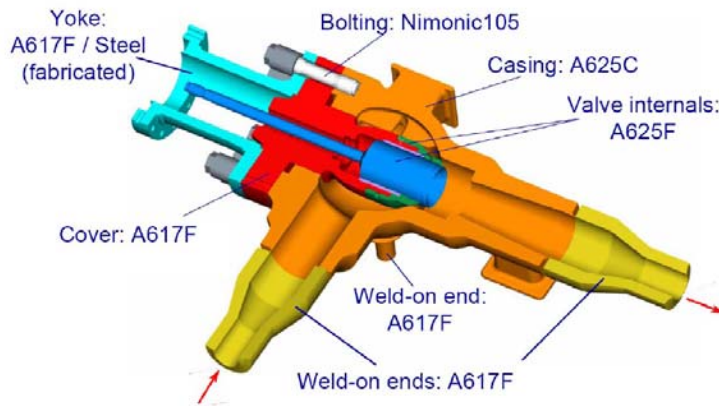

**Valve Bodies**

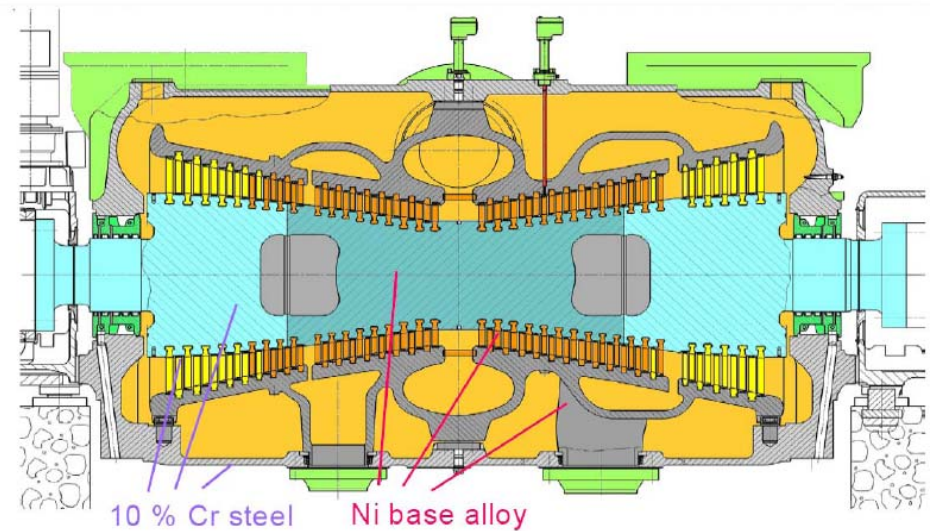

**Turbine Casing**



# Alloys Under Consideration

Solid Solution	Age Hardenable
H230	N105
IN617	H263
IN625	H282
	IN740

# Work Plan Outline

1. Cast each alloy (6.8kg; 50C superheat).
  2. Slice off top of ingot.
  3. Sample top for chemistry: xrf for majors, pins for gasses, turnings for C/S and ICP (if need be).
  4. Cut the ingot in half through the diameter.
  5. Take photos of the ingot halves.
  6. Prepare metallographic samples of the crucible skull material and photo document.
  7. Grain etch one ingot half and photo document.
  8. Measure secondary dendrite arm spacing on one alloy (H282).
  9. Use these measurements and the Dictra predictions to design a homogenization heat treatment for all the alloys.
  10. Homogenize and age the castings.
  11. Prepare and test mechanical test specimens.
  12. Review of microstructure and fracture surfaces.
  13. Oxidation coupons if mechanical performance warrants.
  14. Modify chemistry/heat treatment if required.
  15. Cast additional small ingots of modified chemistry or larger ingots if acceptable.
  16. Repeat portions of 1-14.
- We are working on steps 11 and 12 as of today.

# Our Model Casting Geometry

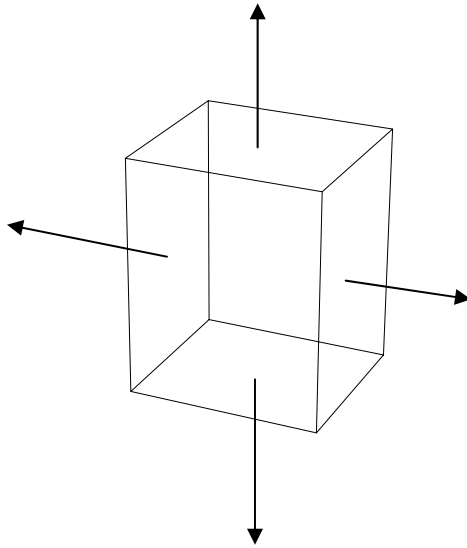

The actual component is nominally 4in thick and “infinite” in the other directions.

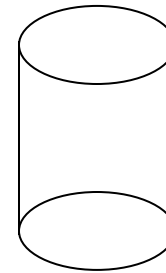

Our casting is nominally 4in in diameter and 4-5in tall.

# “Enhanced” Slow Cooling

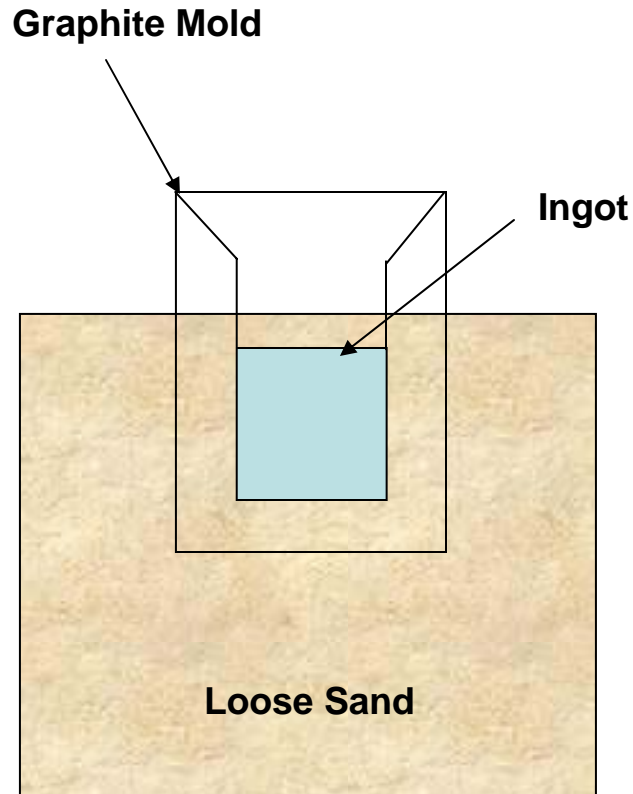

Our casting layout is shown schematically on the left. A permanent graphite mold was used. This mold was surrounded by loose sand such that the top of the casting was below the sand line. This is our attempt to emulate the “semi-infinite” plate model of the turbine casing.

# Nimonic 105 Still in the Mold



When the ingot was cast the mold never showed any “color” which meant that the mold temperature stayed below about 550C. This gave us some confidence that slow cooling was achieved.

# First Ingot Chemistries

	C	Cr	Mo	Co	Al	Ti	Cb	Mn	Si	B	W
Nimonic 105	0.15	14.85	5.00	20.00	4.70	1.10		0.50	0.50	0.05	
	0.16	14.61	5.02	20.04	4.43	1.10		0.51	0.51	0.05	
Haynes 230	0.120	22.00	2.00		0.35			0.70	0.50		14.00
	0.12	21.59	2.01		0.37			0.69	0.50		13.91
Haynes 263	0.070	20.00	5.80	20.00	0.35	2.10		0.50	0.35		
	0.07	19.68	5.74	19.89	0.40	2.04		0.50	0.34		
Haynes 282	0.070	19.50	8.50	10.00	1.50	2.10		0.15	0.15	0.005	
	0.07	19.22	8.48	9.84	1.44	2.08		0.24	0.15	0.01	
IN617	0.120	22.00	9.00	12.50	1.10	0.30		0.50	0.50		
	0.12	21.73	8.96	12.35	1.04	0.31		0.50	0.49		
IN625	0.070	21.00	9.00		0.10	0.10	3.60	0.50	0.35		
	0.07	20.71	8.92		0.15	0.089	3.58	0.49	0.34		
IN740	0.030	25.00	0.50	20.00	1.30	1.50	1.50	0.30	0.30	Fe:	0.70
	0.04	24.71	0.50	20.03	1.24	1.48	1.50	0.30	0.31		0.57

Aims

Results



# Grain Etched Ingot Cross Sections

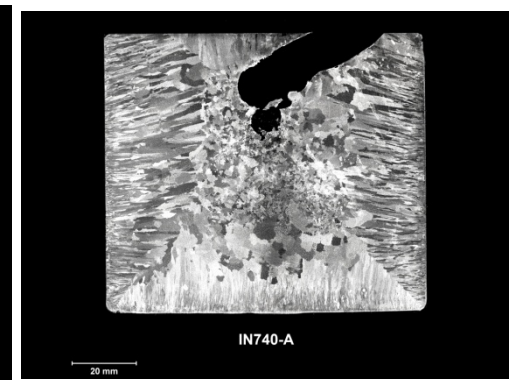
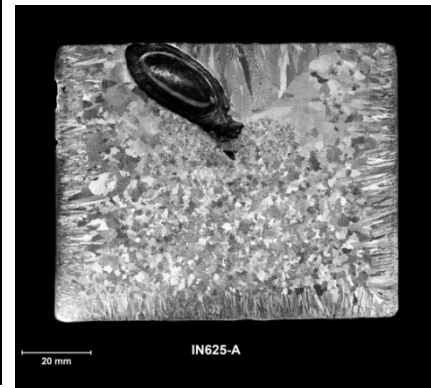
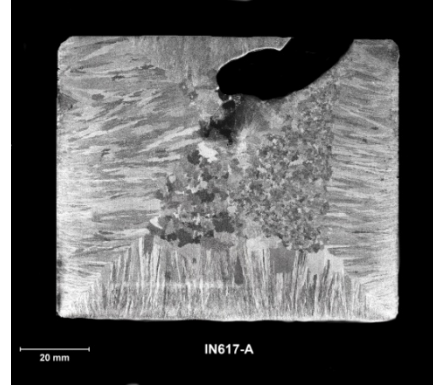
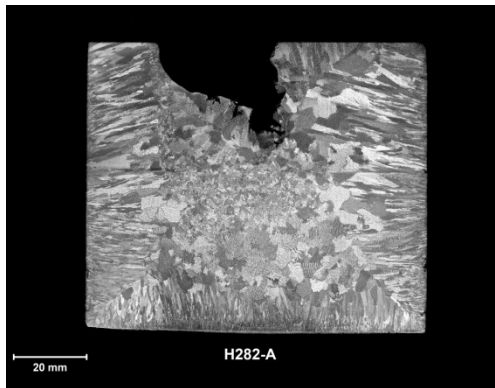
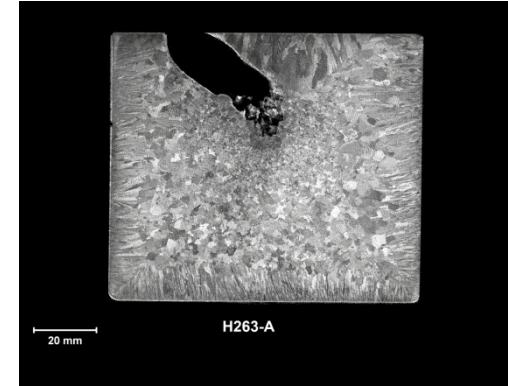
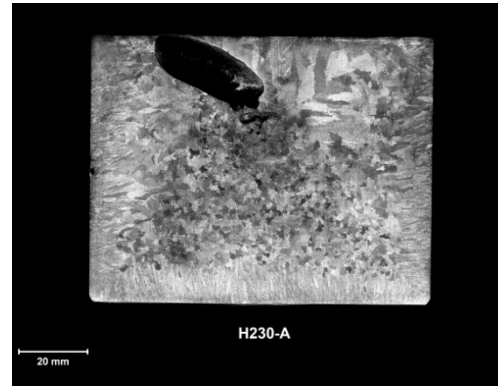
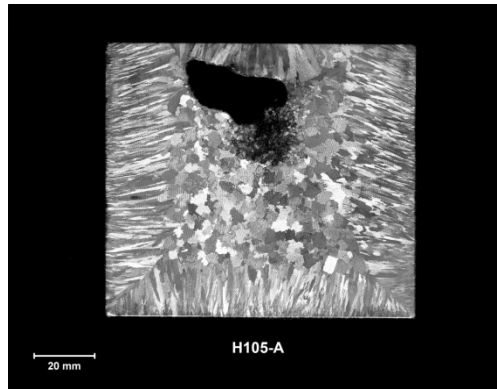

In general, the ingots have a columnar outer band ~1/4-1/3 of the radius thick and an equiaxed core. This is similar to the grain structure we would expect to observe in a large sand cast version of these alloys. Ingots were sectioned to bisect the shrink cavity.

# Nimonic 105—Nominal Composition

	C	Cr	Mo	Co	Al	Ti	Cb	Mn	Si	B	W
Nimonic 105	0.09	14.85	5.00	20.00	4.70	1.20		0.50	0.50	0.01	

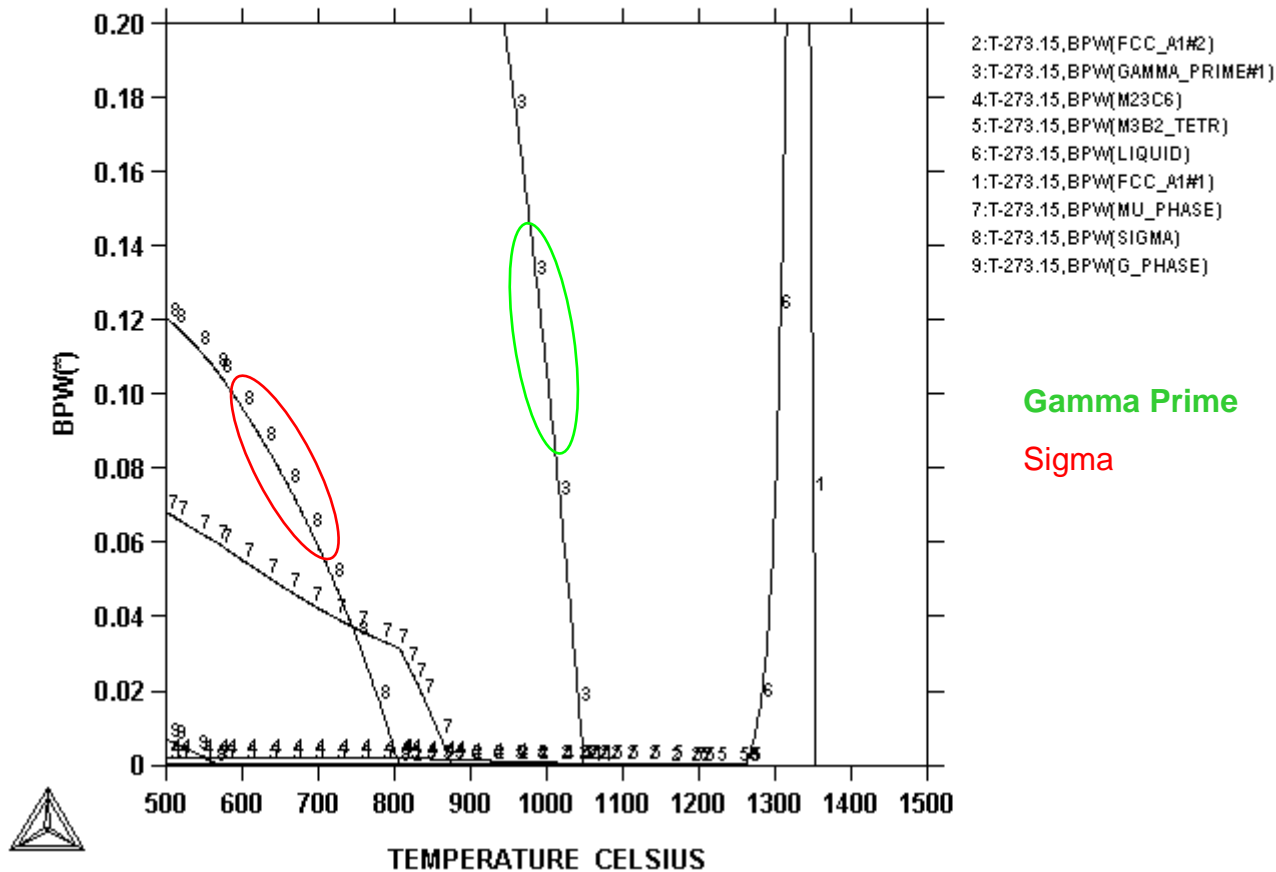

# N105—Solidification

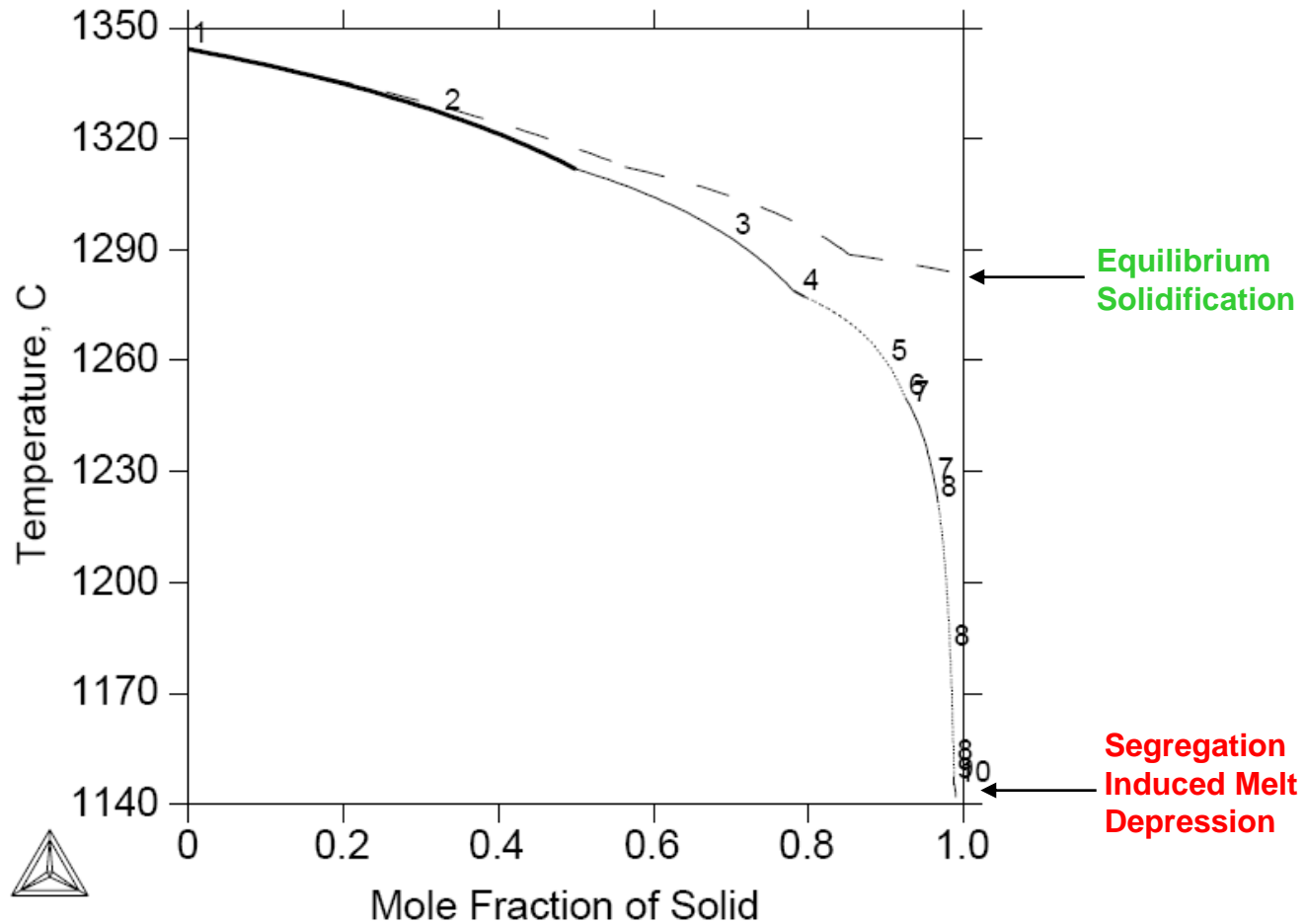

# Nimonic 105

The normalized Scheil predicted segregation in the FCC phase

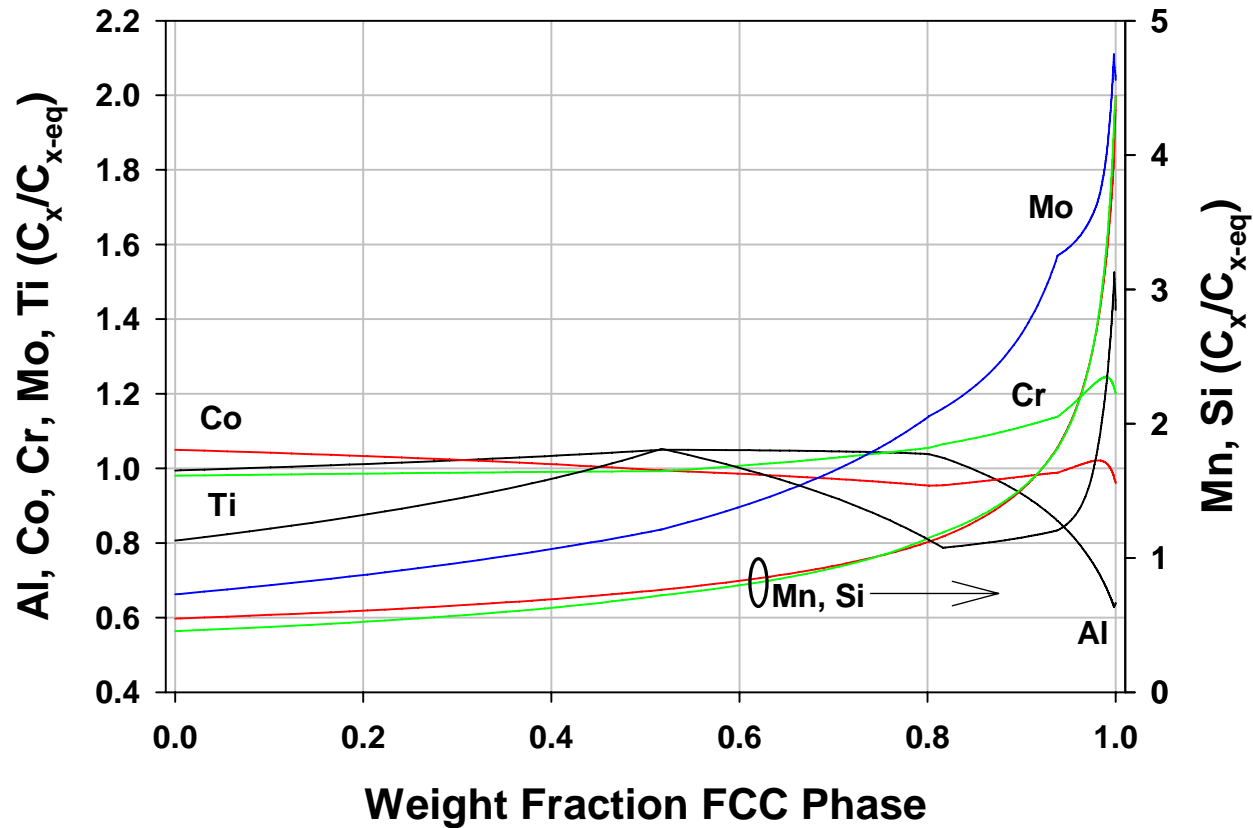

# N105—1100C Heat Treatment

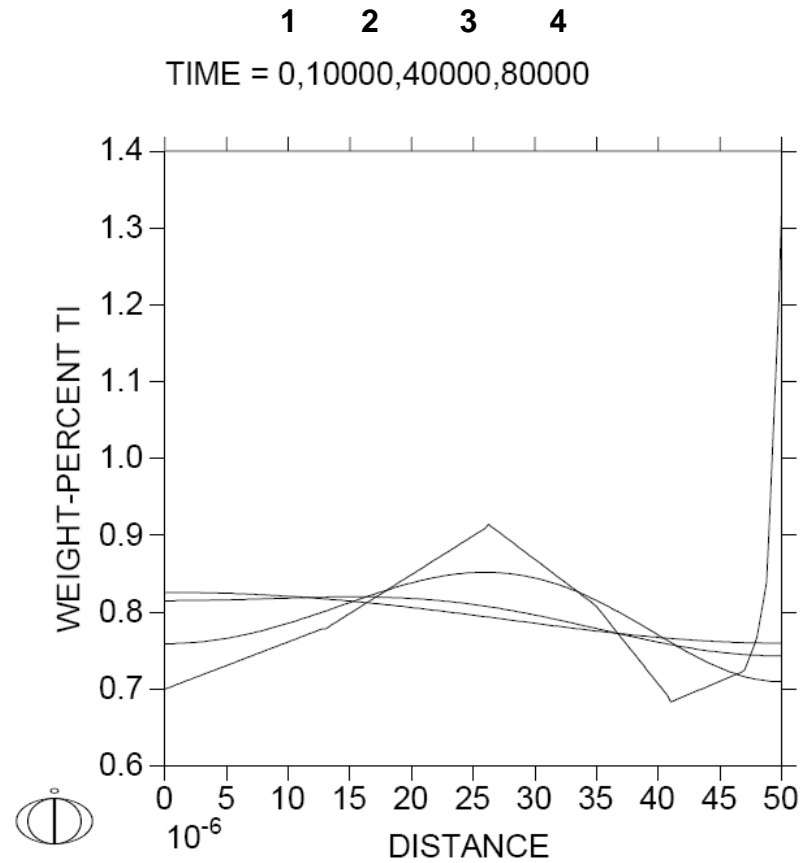
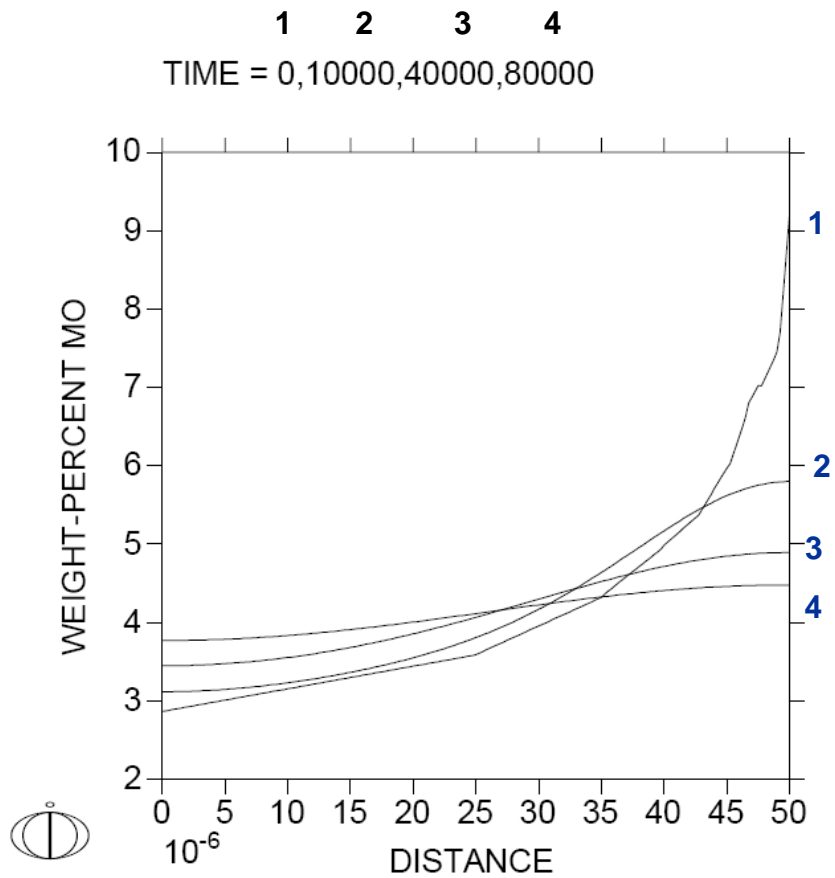

Neither Mo or Ti are fully homogenized even after 22.4h at 1100C.

# Section Summary: As-Cast Profiles

**With 7 alloys and 8 or more alloying elements, there is just too much segregation/diffusion data to show here, but they are available for all the alloys. Here are the highlights:**

- The refractory elements W, Mo, and Nb do not homogenize after ~22h/1100C**
- Significant segregation of the second phase strengthening elements Al, Nb and Ti were observed in many alloys...to the point that 1/2-2/3 of the casting would be considered “lean”.**
- In some cases, Cr poor regions are predicted.**
- Significant Co segregation was observed in some alloys.**
- Significant partitioning of Mn and Si to the interdendritic region was predicted. This result suggests that a turn down in the levels of these elements may be beneficial (e.g., welding).**



# Nimonic 105

## Qualitative Confirmation of the Effectiveness of the Homogenization Heat Treatment



As-Cast

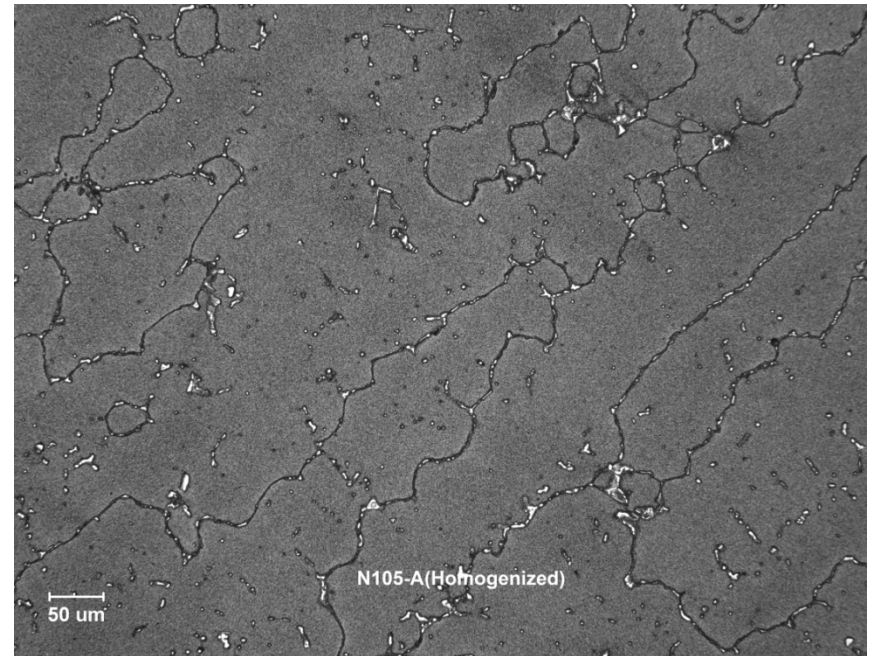

Homogenized

Can the Homogenization cycle replace the solution heat treatment?

# Ingot Cooling Rates

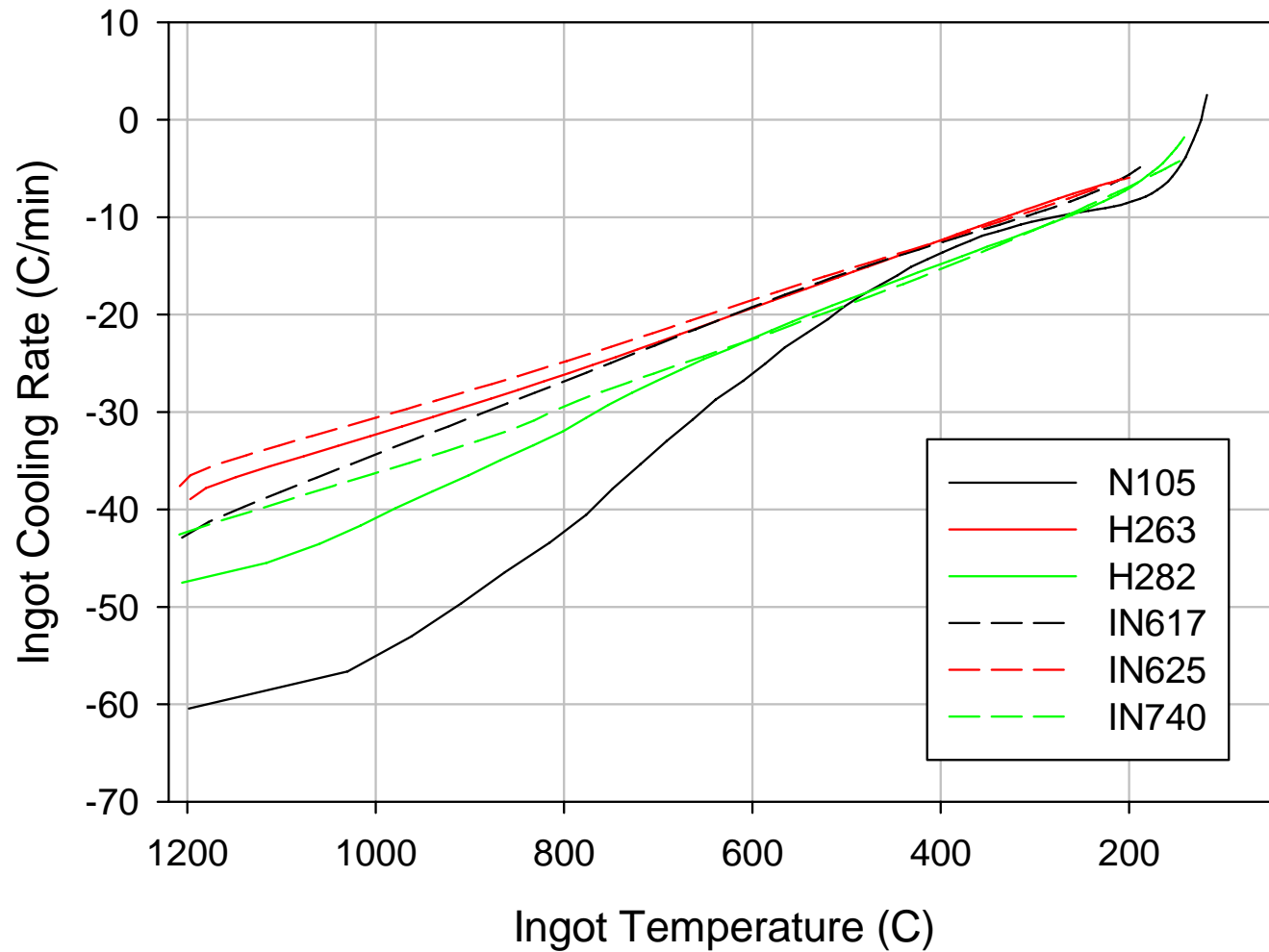

# Alloy Heat Treatments

	Solutionizing Temperature and Time, C	Aging Temperature and Time, C
Nimonic 105	1150C/4h/AC	1050-1065C/16h/AC+850C/16h/AC
Haynes 230	1230C/WQ or rapid air cool	NA
Haynes 263	1150C / rapid air cool	800C/8h/AC
Haynes 282	1121-1149C/thickness dependant/WQ or Rapid Cool	1010C/2h/rapid or air cool then 788C/8h/AC
IN617	1177C / Thickness dependant / AC	NA
IN625	1093-1204C/AC or quench	NA
IN740	1150C/4h/AC	1120C/1h/WQ+850C/16h/AC

# N105—Aged Specimens

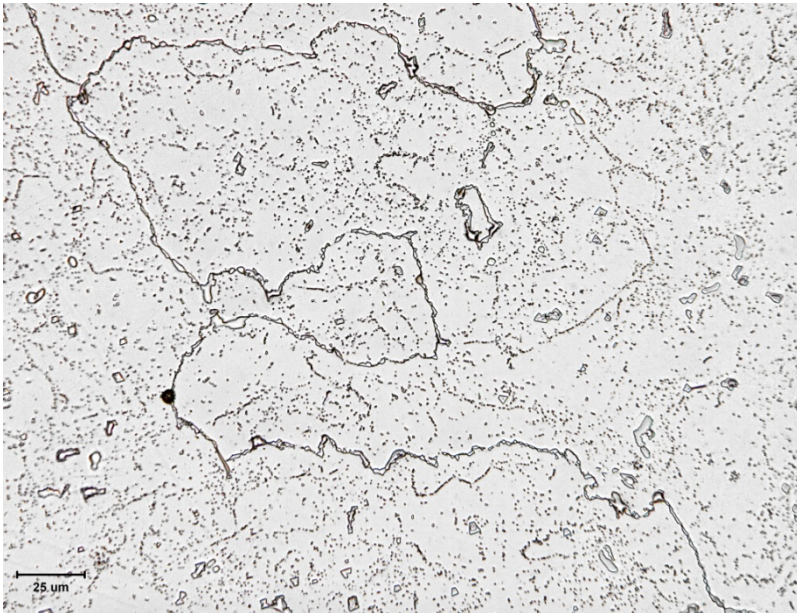

Homogenized and Aged

Hv=347.3

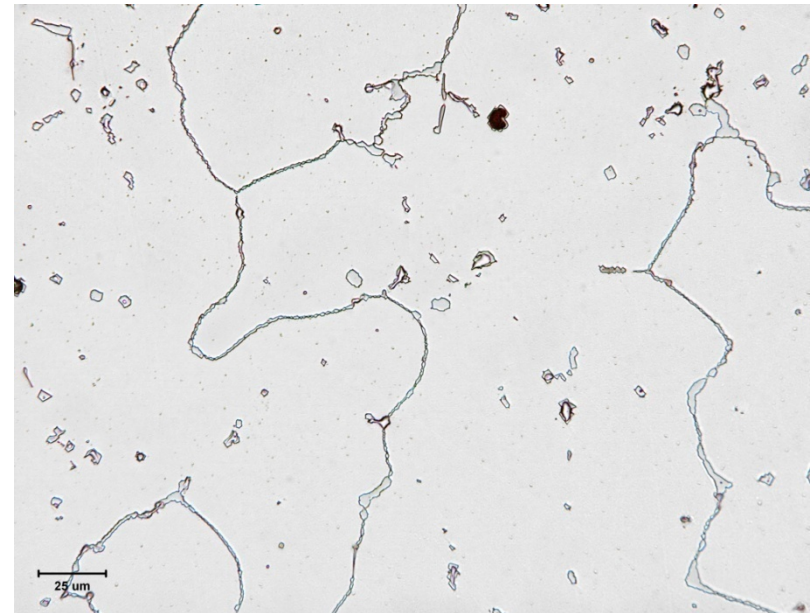

Homogenized, **Solutioned** and Aged

Hv=339.3

Homogenize + **(1150C/4h/AC)** + 1050-1065C/16h/AC + 850C/16h/AC



# H282—Aged Specimens

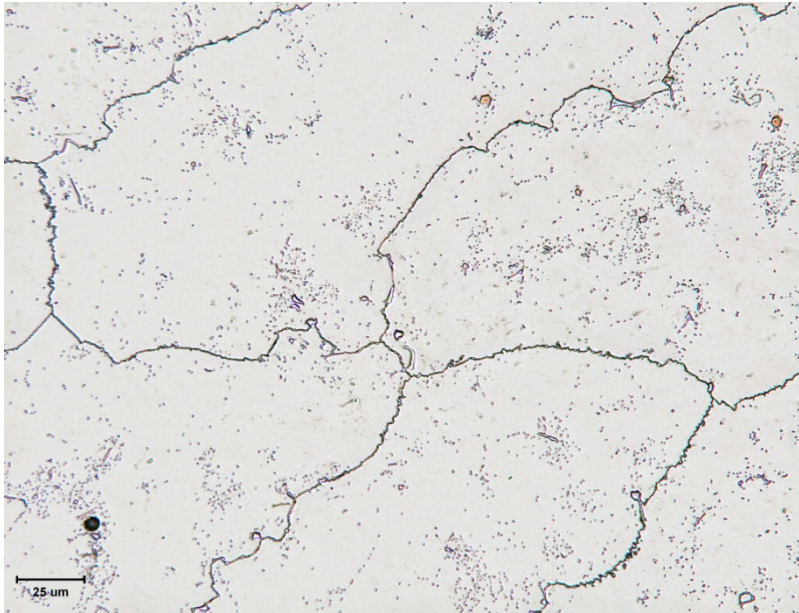

Homogenized and Aged

Hv=294.3

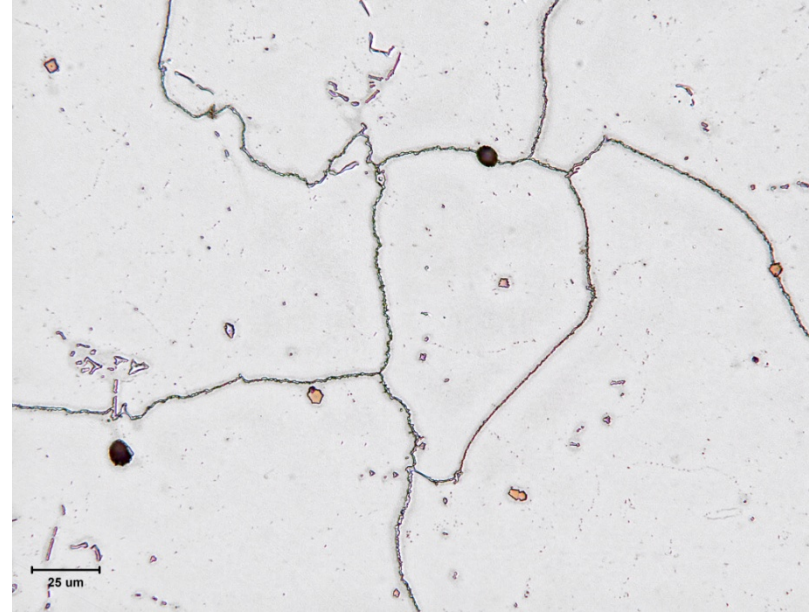

Homogenized, **Solutioned** and Aged

Hv=299.7

Homogenize + **(1150C/4h/AC)** + 1010C/2h/AC + 788C/16h/AC

# IN740—Aged Specimens

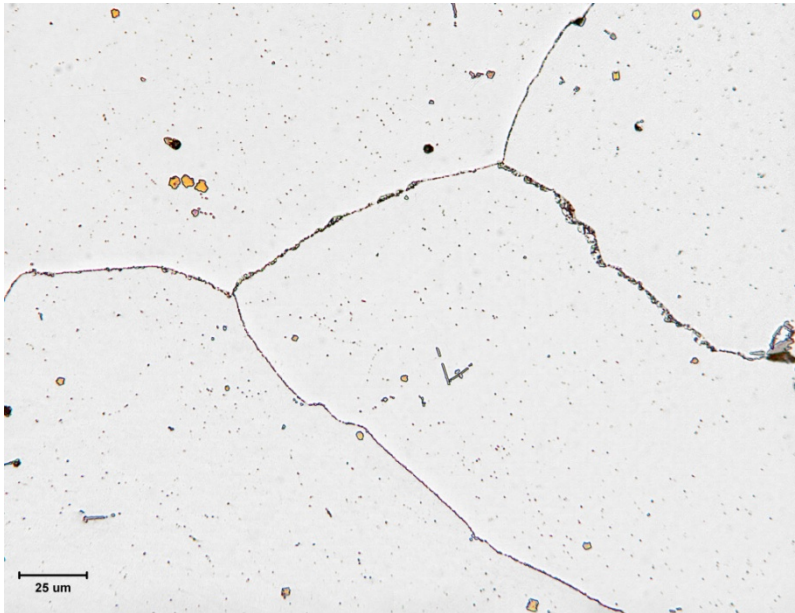

Homogenized and Aged

Hv=290.3

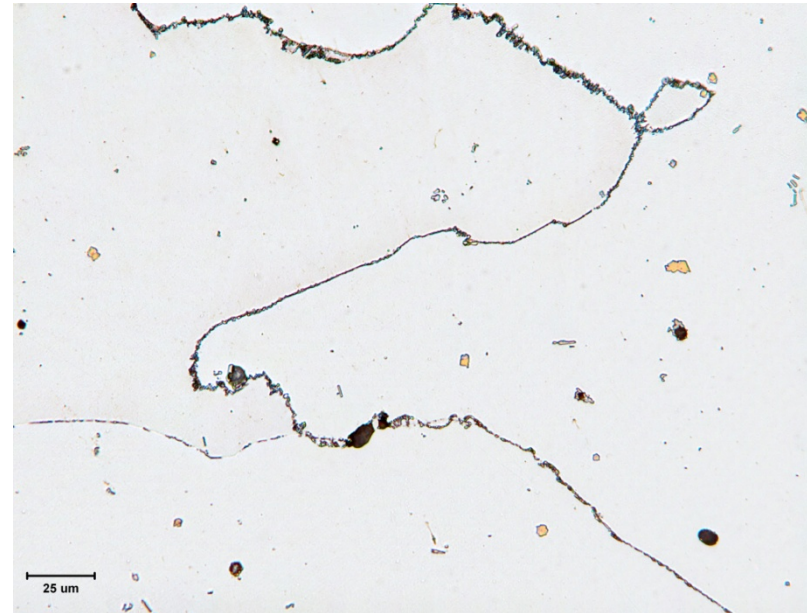

Homogenized, **Solutioned** and Aged

Hv=298.0

Homogenize + **(1150C/4h/AC)** + 1020C/1h/WQ + 800C/16h/AC



# Tensile Bar Layout

The ingot halves were cut into 0.4in wide slabs labeled A, B, etc. from the left side of the original tops. These were cut into 0.4in wide TB blanks labeled A1, A2, etc. from the ingot center.

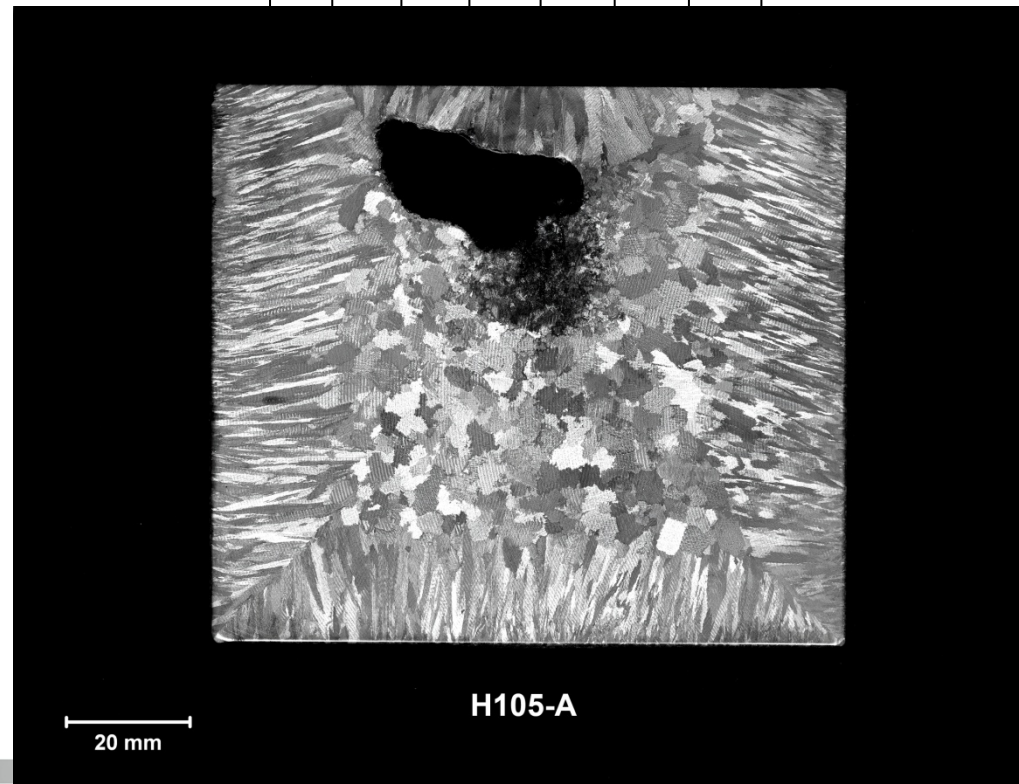
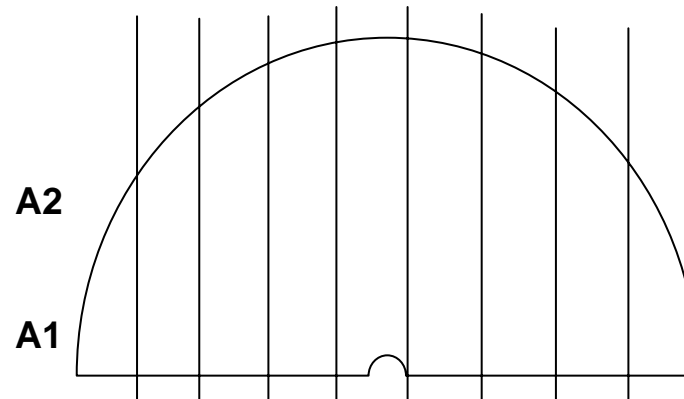

# 800C Hot Tensile Results

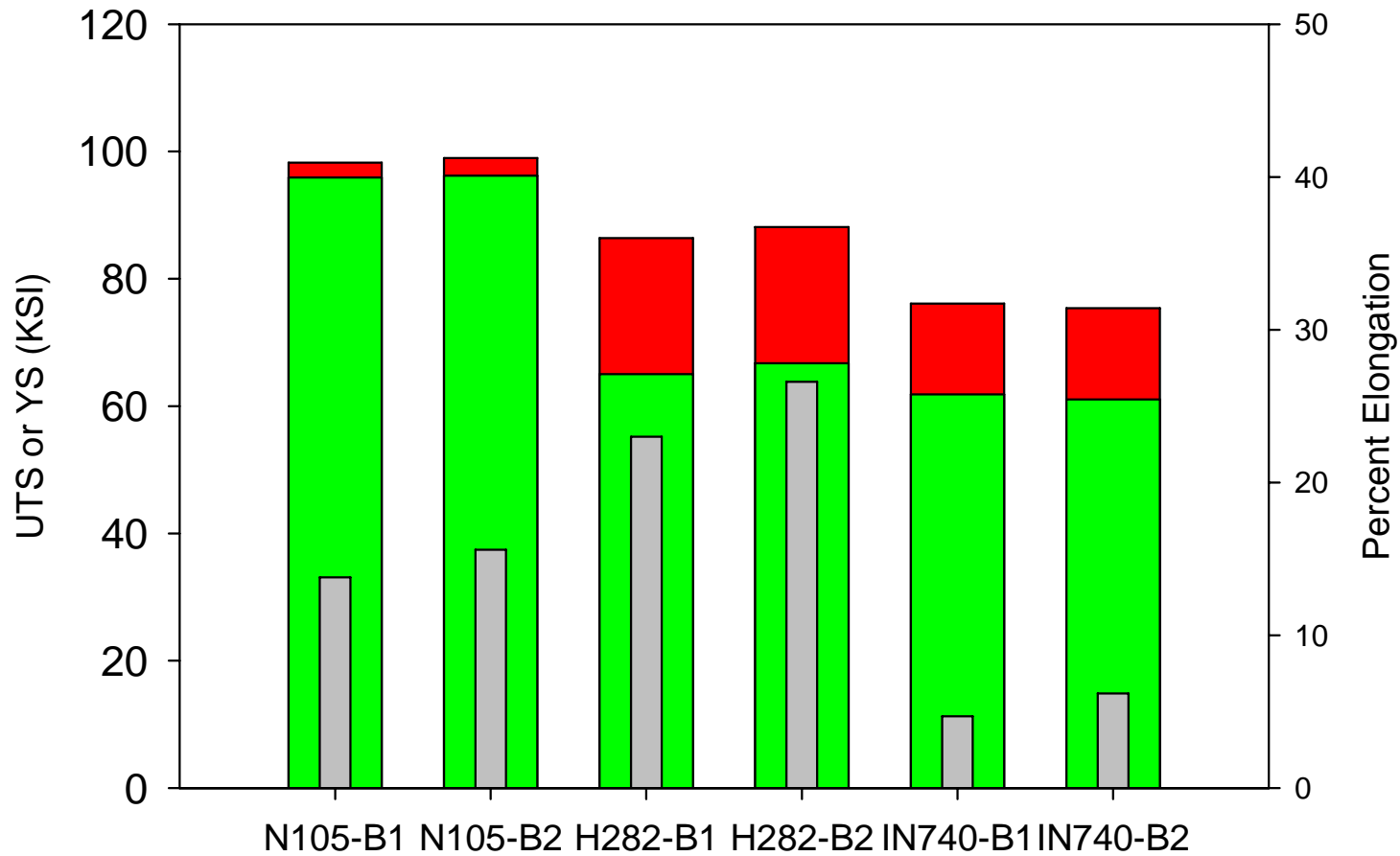

# N105 Fracture



1 mm

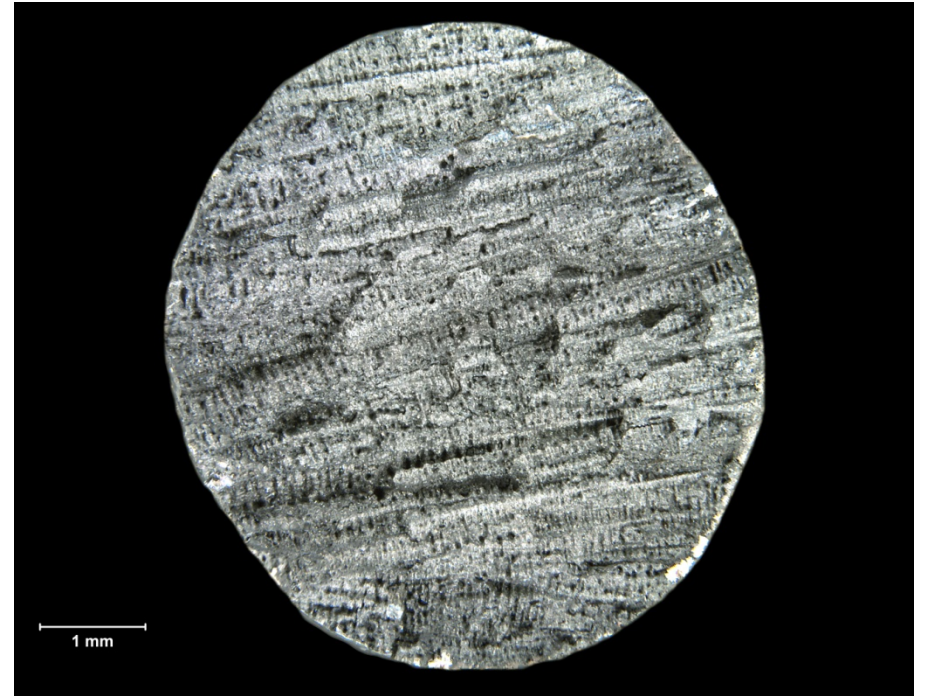

1 mm

# 800C Hot Tensile Results—Continued

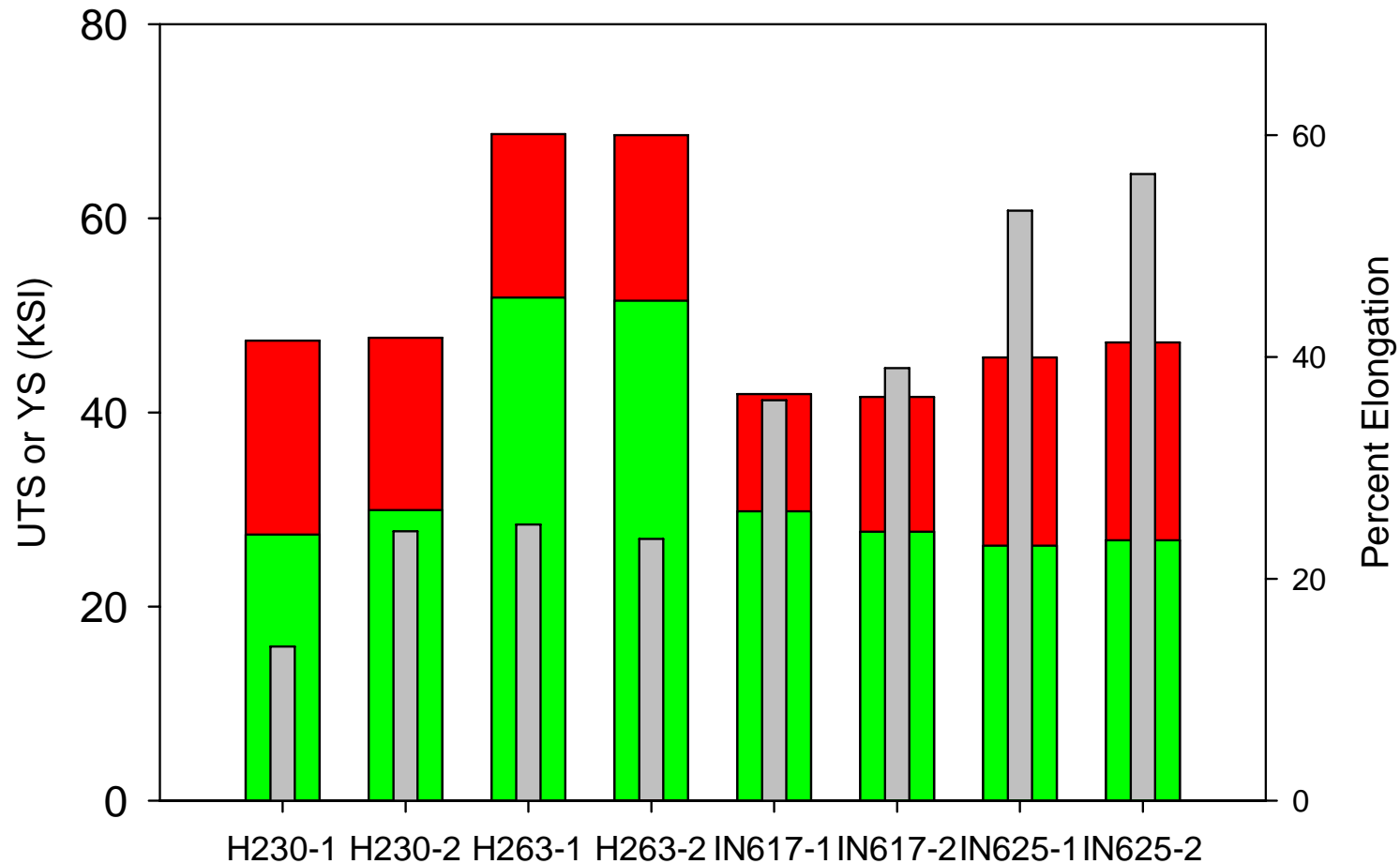

# H263



1 mm

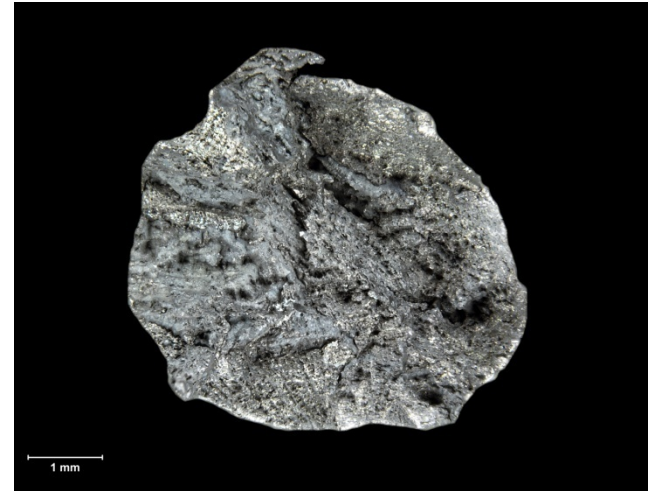

# Preliminary 800C Creep Results

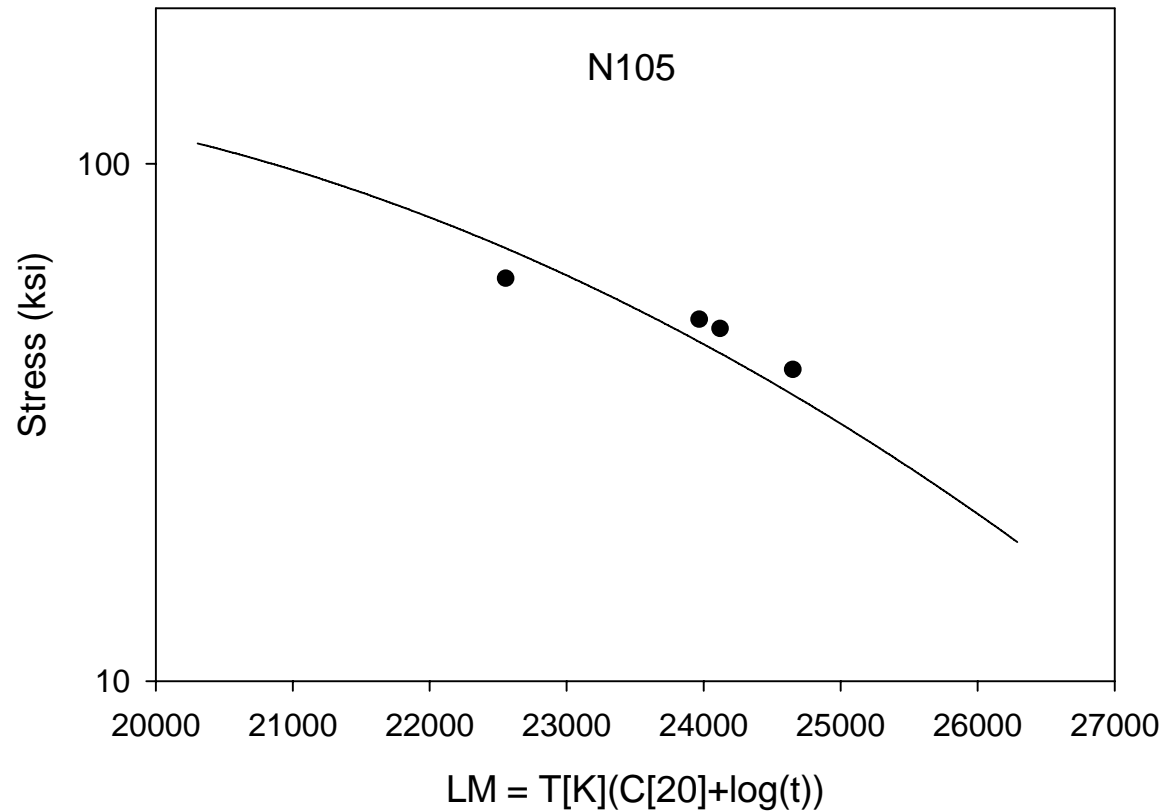

Life (h)	Ksi	MPa
10.5	60	414
217.7	50	345
302.3	48	331
943.5	40	276



# Preliminary 800C Creep Results

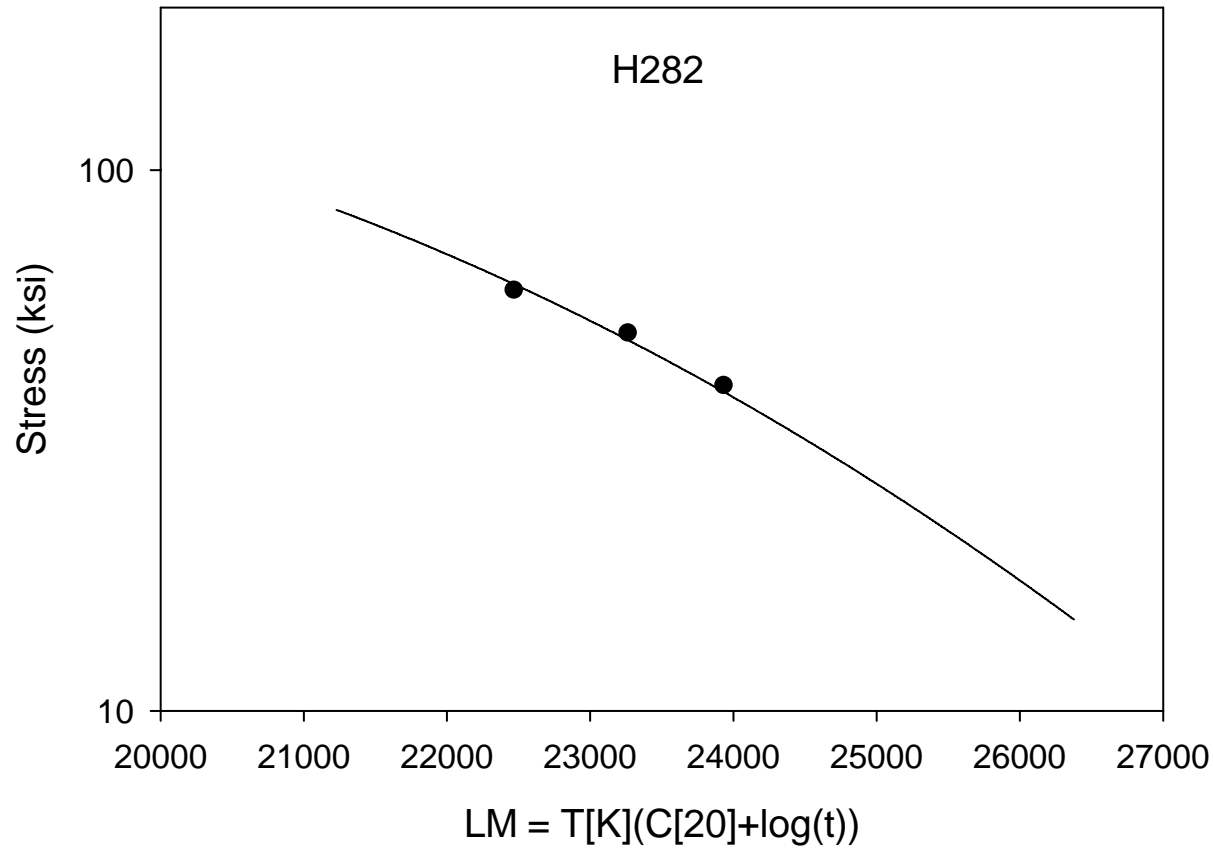

Life (h)	Ksi	MPa
8.7	60	414
47.9	50	345
201.1	40	276

# Preliminary 800C Creep Results

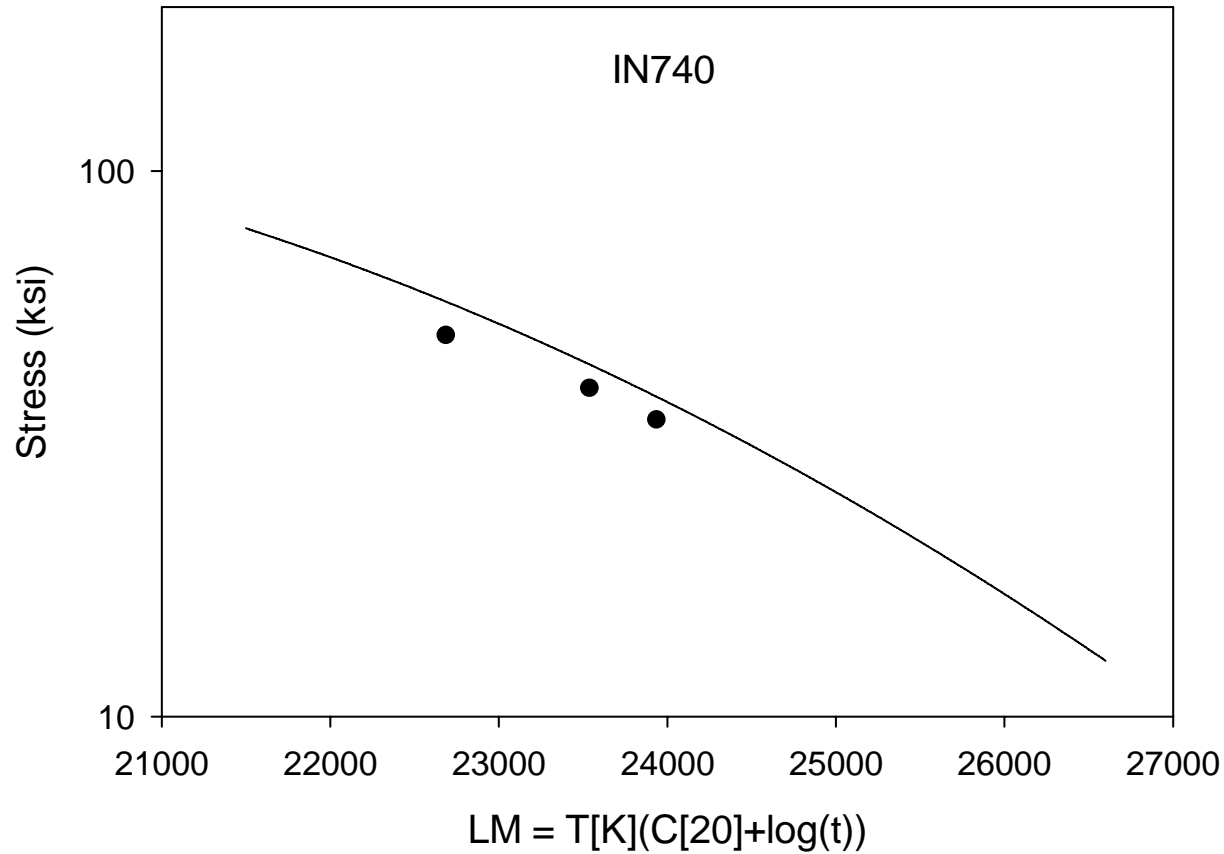

Life (h)	Ksi	MPa
13.9	50	345
86.6	40	276
202.9	35	242

# Creep Testing Remaining Alloys

## H263

Life (h)	Ksi	MPa
~10	40	276
10's	28	193
100's	18	124

## H230, IN617, IN625

Life (h)	Ksi	MPa
~10	20	138
10's	18	124
100's	14	97

# Summary and Path Forward

- **All the castings have been homogenized/aged, specimens have been machined for mechanical testing.**
- **800C hot tensile testing is complete for all alloys (duplicates).**
- **The initial round of creep testing has been completed on the strongest alloys.**
- **The remaining alloys are submitted for creep screening.**
- **The microstructural evaluation is just beginning.**
- **Down-select will begin once preliminary results are available on all alloys.**

# Thank You!



Paul D. Jablonski  
[Paul.Jablonski@NETL.DOE.GOV](mailto:Paul.Jablonski@NETL.DOE.GOV)  
541.967.5982